

EXPERIENCE WITH TORSIONAL VIBRATION AT RECIPROCATING COMPRESSORS

Dr.-Ing. Johann Lenz*, Dr.-Ing. Fikre Boru

KÖTTER Consulting Engineers GmbH & Co. KG
Bonifatiusstraße 400, 48432 Rheine, Germany

lenz@koetter-consulting.com

Abstract

Reciprocating compressors are unavoidable classical solutions in the field of natural and process gas compression with the ability to function over a wide range of operating conditions. The dynamic design of the reciprocating compressor is complicated due to the large number of conditions that have to be satisfied. Since high torsional dynamic stress is often not recognised until damages appear, it is advisable to conduct a detailed torsional vibration analysis when planning a new drive train or modifying an existing one. In this paper, the different measures to influence the torsional behaviour of reciprocating compressors are presented with the help of four case studies.

1 THEORETICAL BACKGROUND

The working principle of the reciprocating compressor leads to torsional loading in the crank shaft. This torsional loading is then transmitted to the optional flywheel, the coupling and the driving motor. Besides the working principle of the compressor, a lot of factors influence the torsional loading of the drive train. The excitation loads responsible for the torsional fatigue loading are explained below.

The piston rod force F_P can be calculated from the cylinder gas forces and the simplified dynamic forces of the piston and piston rod masses as follows:

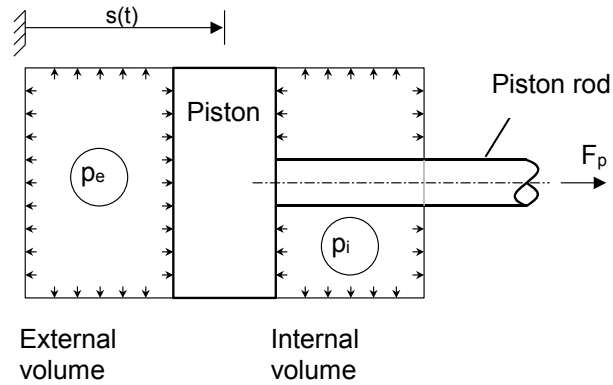

Figure 1: Simplified cylinder

Piston rod force $F_P(t)$:

$$F_p(t) = m_p \cdot a_p(t) + p_i(t) \cdot A_i - p_e(t) \cdot A_e \quad (1)$$

where

m_p = piston and piston rod mass

a_p = piston acceleration

p_{ie} = internal, external cylinder pressure

A_{ie} = internal, external piston area

From the piston rod force and the dynamic force of the crosshead and the reciprocating mass of the connecting rod, one can calculate the radial (F_r) and tangential (F_t) forces (as a function of the crank shaft angle) acting on the crosshead pin. The tangential force component is responsible for the torque loading of the crank shaft.

Figure 2 depicts the piston rod force and the resultant moment load of a single crank shaft of a typical slowly rotating natural gas reciprocating compressor for one complete crank shaft revolution.

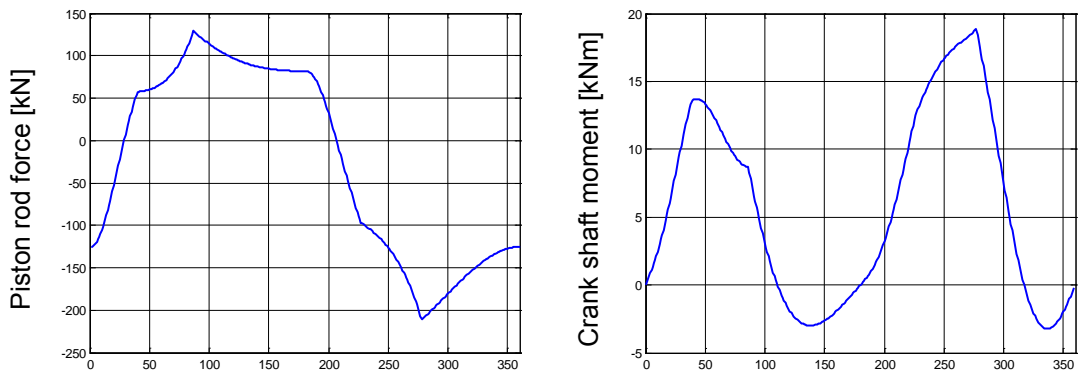

Figure 2: *Piston rod force and crank shaft moment, variation of a typical natural gas piston compressor as a function of crank angle*

In order to analyse the resulting torsional vibration, the spectrum of the dynamic components of the torque is generated as shown in figure 3.

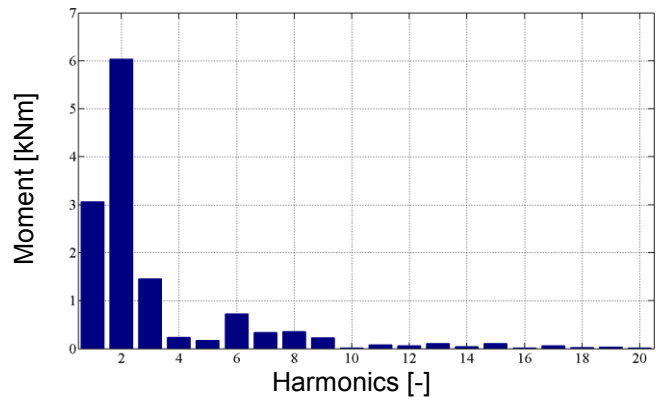

Figure 3: *Spectrum of excitation torque*

The torque spectrum is composed of a number of harmonic components which are multiples of the compressor rotational speed. The value of these harmonic components depends on the operating condition of the compressor.

The torque spectrum presented above acts on the “torsionally flexible” drive train. The drive train is composed of a number of elements having moment of inertia, torsional damping and torsional stiffness properties.

Before installation of reciprocating compressors a torsional vibration study should be conducted in order to check if the allowable loadings are not violated by the planned operation of the compressor. Besides the allowable load levels of the drive train components, the allowable maximum vibration amplitude and the allowable safety margin between resonance and excitation frequency have to be checked.

The results of the torsional vibration analysis depend on the quality of the equivalent physical model and the consideration of the different conditions, which may arise during operation of the compressor. The model should be accurate enough so that it is sensitive to the smallest changes, for example a different coupling manufacturer. In practice, it is advisable to check the torsional vibration level by measurements during commissioning of the drive train.

2 CASE STUDIES

2.1 Problems after retrofit with an active suction valve unloader

Since the retrofit of an active suction valve unloader to a reciprocating compressor led repeatedly to failures of its coupling, a basic investigation of the torsional vibration was conducted on an equivalent drive train to determine the influence of the unloader. The analysed reciprocating compressor is a 2-stage, boxer-type compressor with 2,100 kW coupling power having a loaded operating speed range from 600 rpm to 1,000 rpm. In order to broaden the range of the volume flow, an active unloader was retrofitted on both stages of the drive train. An equivalent torsional physical (figure 4) and mathematical model was generated. The first two eigenvalues and their corresponding eigenforms are shown in the Campbell diagram (figure 5).

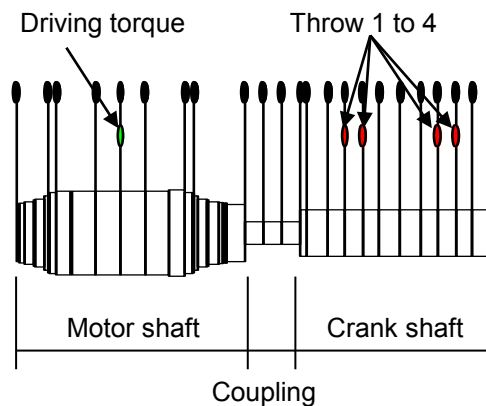

Figure 4: Torsional physical model of the investigated drive train

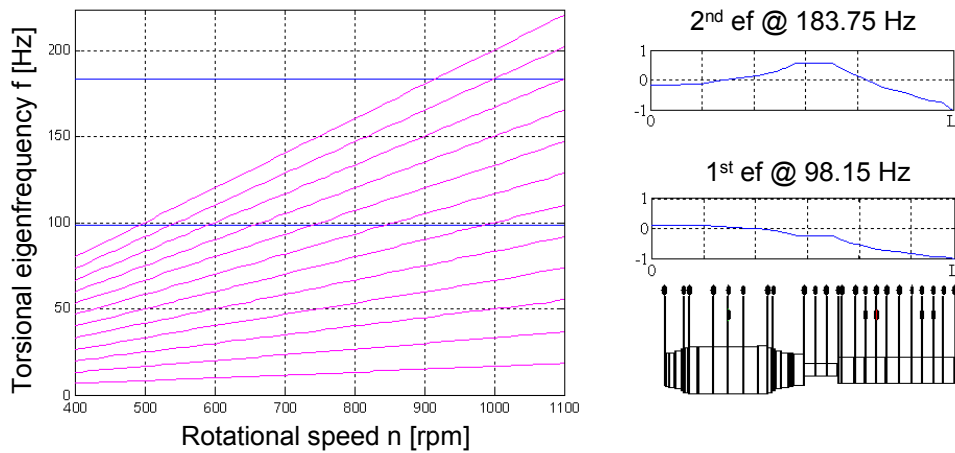

Figure 5: Campbell diagram as well as 1st and 2nd torsional eigenform at the drive train

The suction valve unloaders influence the excitation torque spectrum of the drive train. [Figure 6](#) shows the torque spectra for different settings of the unloaders. The dynamic response of the drive train was analysed for the unloader settings. In [figure 7](#) the torque amplitude in the coupling element is given for an operation between 400 rpm and 1,100 rpm.

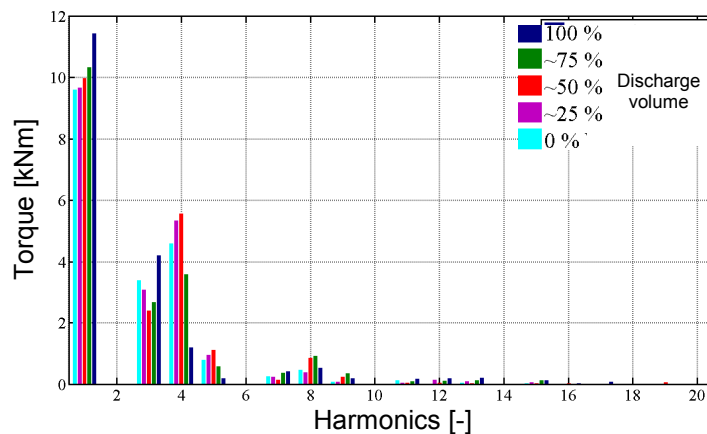

Figure 6: Torque spectra of the 2nd throw (2nd stage) of the 4-cylinder reciprocating compressor operating at 750 rpm

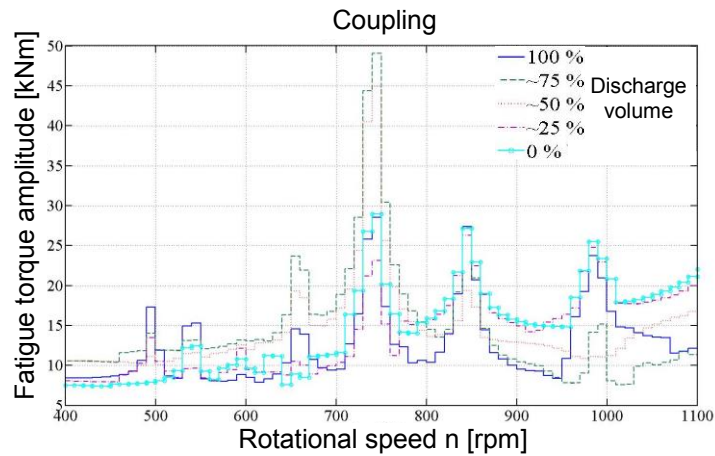

Figure 7: Torque amplitude of the coupling for different settings of the suction valve unloader, operation speed between 400 rpm and 1,100 rpm

Figure 7 shows that the dynamic torque of the coupling was considerably higher for the 75 % setting than for 100 % (i. e. deactivated unloader). This was due to the change in the 8th harmonic of the excitation, which interfered with the 1st torsional eigenfrequency.

This example shows that - depending on the system damping and the selected rotational speed - large dynamic torque may result from the activation of the unloaders. Hence, it is always advisable to conduct a torsional vibration analysis before retrofitting an existing reciprocating compressor with an active suction valve unloader.

2.2 Resonance of the connecting shaft

Reciprocating compressors are often applied for liquefaction of natural gas. Damage at the metal disc coupling of ten similar 2-stage reciprocating compressors was registered after different operation life time. The compressors with a coupling power of 350 kW were operated at a constant rotational speed of 600 rpm. The drive train consists of an electric motor connected to the compressor (with two double acting cylinders) by two metal disc couplings, an interconnecting shaft and a flywheel (figure 8).

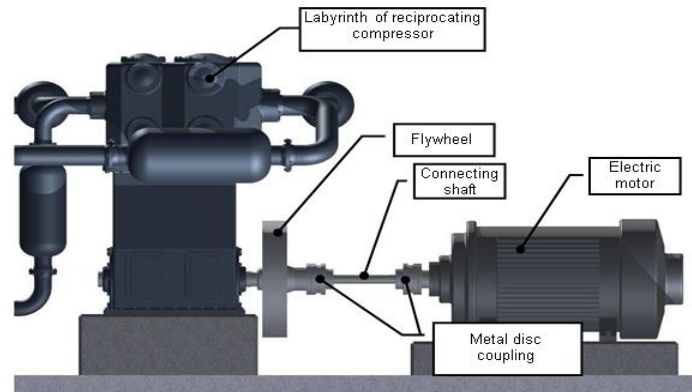

Figure 8: Two-stage reciprocating compressor with metal disc coupling and connecting shaft

For the preliminary investigation of the possible source of the problem, the calculated torsional eigenfrequencies of the drive train were presented in the Campbell diagram in [figure 9](#).

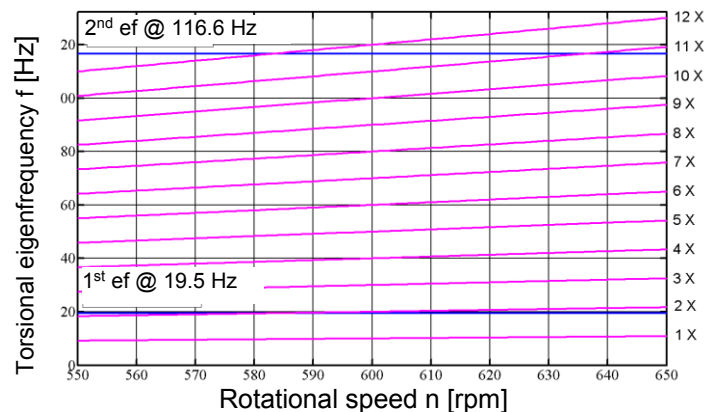

Figure 9: Campbell diagram with calculated eigenfrequencies (ef.) to determine the possible resonance speed

It can be seen that in the neighbourhood of the operation speed of 600 rpm there was an interference between the 1st torsional eigenfrequency (19.5 Hz) and the 2nd excitation harmonic. The torsional vibration at the connecting shaft was measured as shown in [figure 10](#). [Figure 11](#) shows the amplitude spectrum of the measured torque.

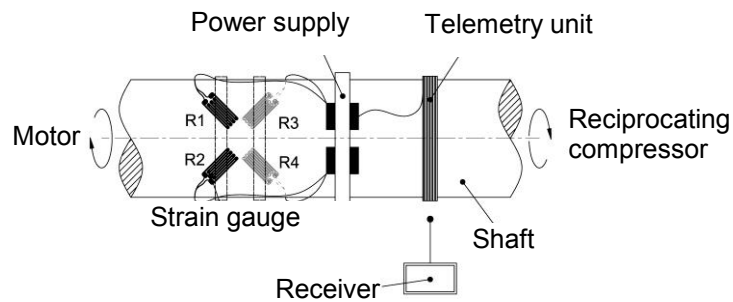

Figure 10: Principle layout of a torque measurement system

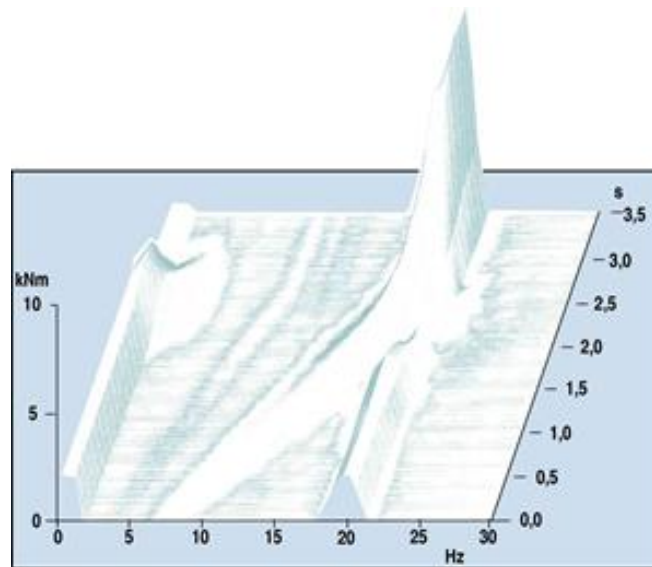

Figure 11: Amplitude spectrum of the torque for start-up of the compressor

During running up of the compressor, a large torsional resonance at about 20 Hz was recorded. To describe the torsional mode, a vector diagram of the measured torque was used as shown in [figure 12](#).

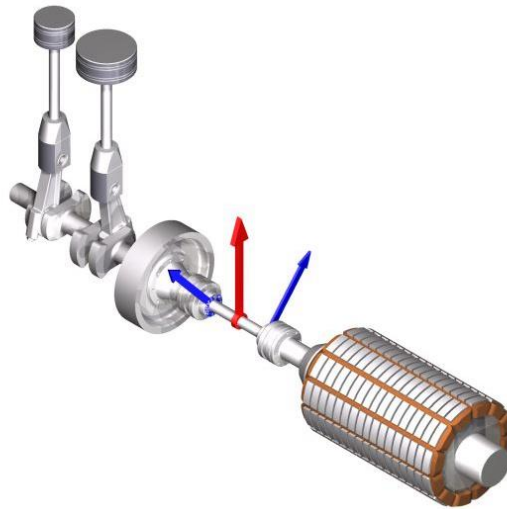

Figure 12: Vector diagram of the measured torque of the drive train

From the vector presentation it can be seen that the main torsional deformation occurred in the connecting shaft. As an easy corrective measure the diameter of the connecting shaft was increased. This moved the calculated 1st torsional eigenfrequency up to 26 Hz. Since this corrective measure was implemented at all compressors, there have not been coupling failures due to torsional vibration anymore.

2.3 Influence of damping

Expanding the operation speed range of two reciprocating compressors for a natural gas storage resulted in a failure of the lubrication system (driven by the crank shaft) of both drive trains after a short operation life time. A measurement showed that torsional resonance vibration was the cause for this failure. For this drive train the customer decided to run the drive train at constant speeds of 750 rpm, 850 rpm and 1,000 rpm. Such decisions limit the flexibility of the plant, hence other possible solutions are discussed below.

An alternative is to replace the metal disc coupling which is almost rigid and has a very low damping, with an elastic coupling in order to torsionally decouple the motor shaft from the crank shaft. Additionally, the elastic coupling brings damping into the drive train. However, the application of elastic coupling results in changing the dynamic property. Hence, a careful torsional analysis is required before such an implementation.

Below, a principle investigation of the coupling effect is presented for a six-cylinder natural gas (reciprocating) compressor with an elastic coupling and flywheel. A torsional finite element model was developed for the drive train. Then, an appropriate metal disc coupling was selected. Figures 13 and 14 show calculated eigenfrequencies and eigenforms of the drive train with the elastic (figure 13) and the metal disc (figure 14) coupling.

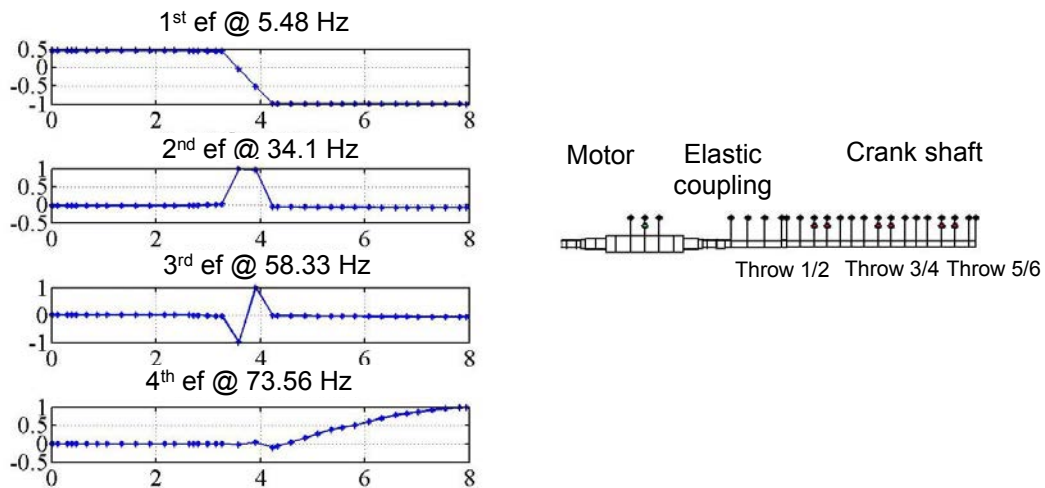

Figure 13: Calculated eigenvalues of a six-cylinder reciprocating compressor with elastic coupling

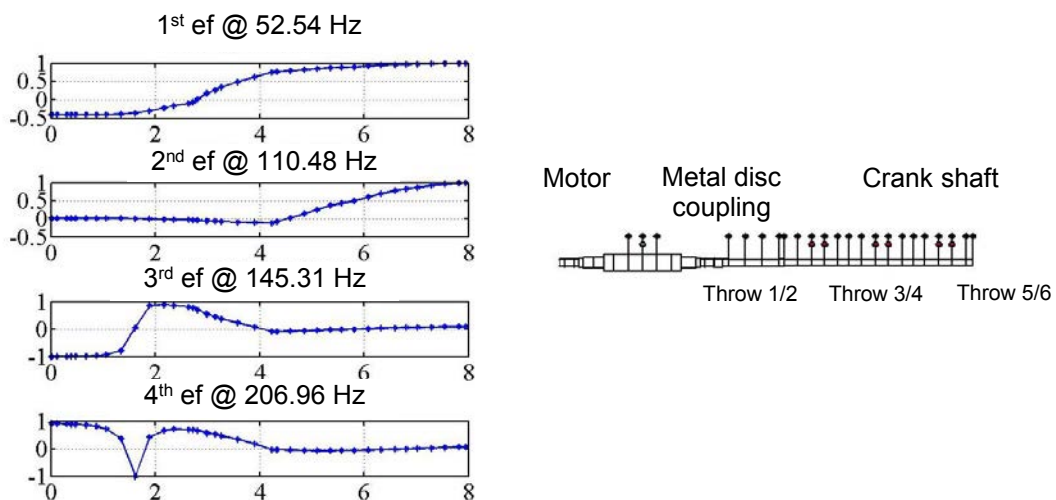

Figure 14: Calculated eigenvalues of a six-cylinder reciprocating compressor with metal disc coupling

One can see that the elastic coupling gives three natural frequencies below the 1st crank shaft natural frequency. These natural frequencies are torsional vibrations within the coupling and hence do not exist in the system with metal disc coupling. Using an elastic coupling the excitation of the eigenmodes with large twisting within the coupling leads to a large power dissipation which may lead to an overheating of the coupling elements resulting in coupling failure. Hence, an additional control of the power dissipation is unavoidable for systems with elastic coupling. The 1st crank shaft eigenfrequency of the drive train with metal disc coupling is 52.5 Hz, whereas that of the drive train with elastic coupling is 73.6 Hz. Figure 15 shows the Campbell diagram of both assemblies to determine the possible resonance operation speeds between 450 rpm and 1,150 rpm.

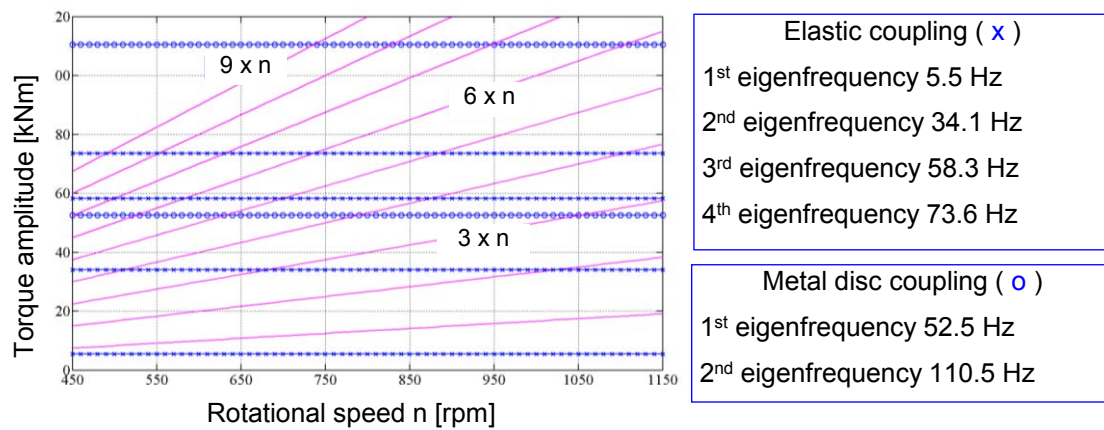

Figure 15: Campbell diagram of the drive train with elastic and metal disc coupling

In reciprocating compressors with variable operation speed, it is not possible to completely avoid the excitation of all eigenfrequencies due to higher harmonics of the rotation frequency. One way to maintain the torsional amplitude within an acceptable limit is to use a coupling with damping properties. The effect of different coupling damping on the dynamic torsional response of the drive train (discussed above) is shown in figure 16.

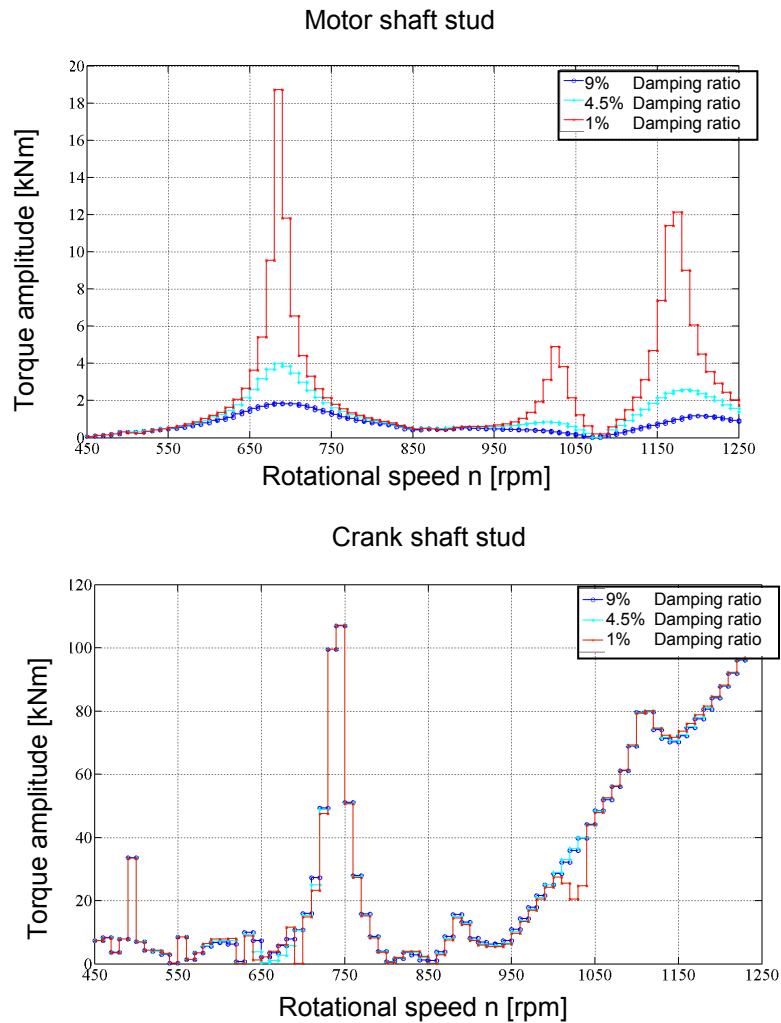

Figure 16: Comparison of the torsional loading of the motor shaft stud (top) and crank shaft stud (bottom) for different damping ratio

The calculation results show that damping ratio has a crucial influence in attenuating the torque amplitude level in the motor shaft stud. Unlike the motor shaft stud, the torque level in the crank shaft stud is irresponsive to variation of the coupling damping ratio. At the resonance speed of around 750 rpm in the crank shaft stud the 4th eigenfrequency is excited by the 6th harmonics. Since the coupling elements are almost static (nodes) for the 4th eigenform, the variation of coupling damping ratio plays an insignificant role for this resonance.

2.4 Influence of dynamic absorber

There are different ways to reduce the dynamic torque at the resonance speed of 750 rpm. One possible method is the installation of either an undamped or damped torsional dynamic absorber directly on the crank shaft. An undamped torsional dynamic absorber removes the 4th eigenfrequency but results in two new eigenfrequencies, one above and one below the previous value. As shown in [figure 17](#), the dynamic torque level at the two new resonance speeds (resulting from the new eigenvalues) is significantly lower than the previous level. Including damping to the absorbers will further reduce the torque level as illustrated in [figure 18](#).

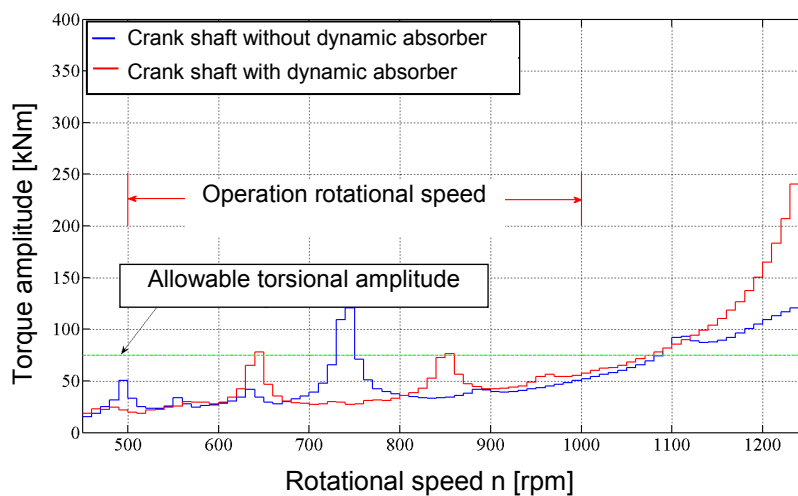

Figure 17: Torque level at the crank shaft stud with and without torsional dynamic absorber

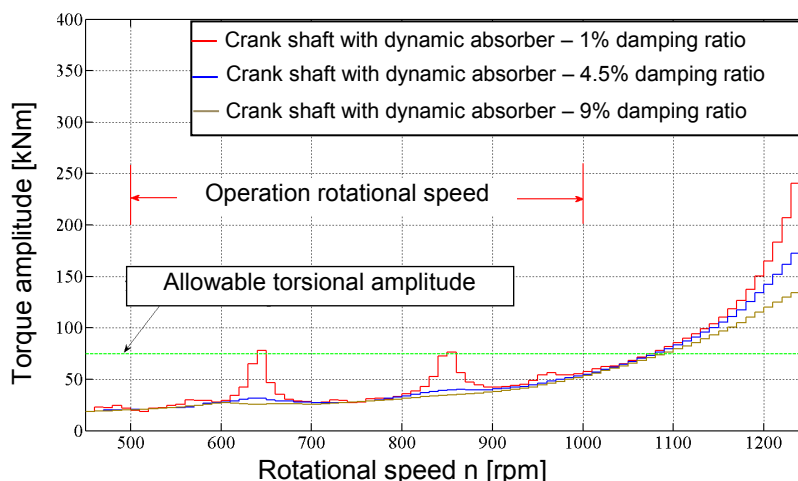

Figure 18: Influence of damping on the torsional dynamic absorber on the torque level

3 CONCLUSION

Torsional vibration at reciprocating compressors cannot be identified on site with simple measuring methods like e.g. measurement of the casing vibration. Often high torsional dynamic stress is not recognised until damages appear. Hence, it is advisable to conduct a detailed torsional vibration analysis when planning a new drive train or modifying an existing one. Different tools to influence the torsional vibration behaviour of a reciprocating compressor are possible. We recommend to check the results of the analysis by a strain gauge measurement to ensure the safety of the plant.